

阅读申明

- 1.本站收集的数据手册和产品资料都来自互联网，版权归原作者所有。如读者和版权方有任何异议请及时告之，我们将妥善解决。
- 2.本站提供的中文数据手册是英文数据手册的中文翻译，其目的是协助用户阅读，该译文无法自动跟随原稿更新，同时也可能存在翻译上的不当。建议读者以英文原稿为参考以便获得更精准的信息。
- 3.本站提供的产品资料，来自厂商的技术支持或者使用者的心得体会等，其内容可能存在描述上的差异，建议读者做出适当判断。
- 4.如需与我们联系，请发邮件到marketing@iczoom.com，主题请标有“数据手册”字样。

Read Statement

1. The datasheets and other product information on the site are all from network reference or other public materials, and the copyright belongs to the original author and original published source. If readers and copyright owners have any objections, please contact us and we will deal with it in a timely manner.
2. The Chinese datasheets provided on the website is a Chinese translation of the English datasheets. Its purpose is for reader's learning exchange only and do not involve commercial purposes. The translation cannot be automatically updated with the original manuscript, and there may also be improper translations. Readers are advised to use the English manuscript as a reference for more accurate information.
3. All product information provided on the website refer to solutions from manufacturers' technical support or users the contents may have differences in description, and readers are advised to take the original article as the standard.
4. If you have any questions, please contact us at marketing@iczoom.com and mark the subject with "Datasheets" .

NPN Silicon Digital Transistor

- Switching circuit, inverter, interface circuit, driver circuit
- Built in bias resistor ($R_1=2.2k\Omega$, $R_2=2.2k\Omega$)

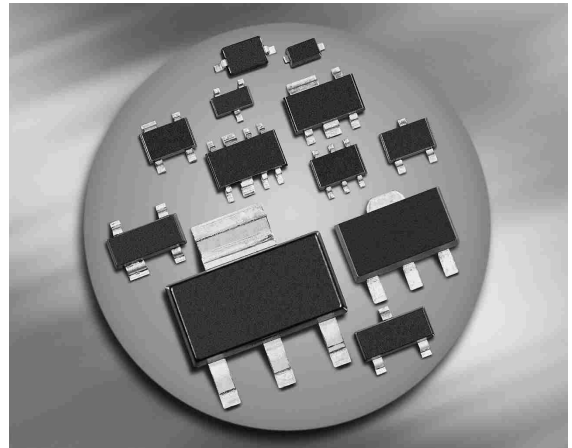
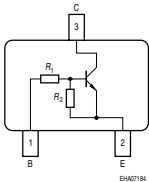
BCR103F
BCR103L3/T

Type	Marking	Pin Configuration						Package
		1=B	2=E	3=C	-	-	-	
BCR103F	WAs	1=B	2=E	3=C	-	-	-	TSFP-3
BCR103L3	WA	1=B	2=E	3=C	-	-	-	TSLP-3-4
BCR103T	WAs	1=B	2=E	3=C	-	-	-	SC75

Maximum Ratings

Parameter	Symbol	Value	Unit
Collector-emitter voltage	V_{CEO}	50	V
Collector-base voltage	V_{CBO}	50	
Emitter-base voltage	V_{EBO}	5	
Input on voltage	$V_{i(on)}$	10	
Collector current	I_C	100	mA
Total power dissipation-	P_{tot}		mW
BCR103F, $T_S \leq 128^\circ\text{C}$		250	
BCR103L3, $T_S \leq 135^\circ\text{C}$		250	
BCR103T, $T_S \leq 109^\circ\text{C}$		250	
Junction temperature	T_j	150	$^\circ\text{C}$
Storage temperature	T_{stg}	-65 ... 150	

Thermal Resistance

Parameter	Symbol	Value	Unit
Junction - soldering point ¹⁾	R_{thJS}		K/W
BCR103F		≤ 90	
BCR103L3		≤ 60	
BCR103T		≤ 165	

Electrical Characteristics at $T_A = 25^\circ\text{C}$, unless otherwise specified

Parameter	Symbol	Values			Unit
		min.	typ.	max.	

DC Characteristics

Collector-emitter breakdown voltage $I_C = 100 \mu\text{A}, I_B = 0$	$V_{(BR)CEO}$	50	-	-	V
Collector-base breakdown voltage $I_C = 10 \mu\text{A}, I_E = 0$	$V_{(BR)CBO}$	50	-	-	
Collector-base cutoff current $V_{CB} = 40 \text{V}, I_E = 0$	I_{CBO}	-	-	100	nA
Emitter-base cutoff current $V_{EB} = 10 \text{V}, I_C = 0$	I_{EBO}	-	-	3.5	mA
DC current gain ²⁾ $I_C = 20 \text{mA}, V_{CE} = 5 \text{V}$	h_{FE}	20	-	-	-
Collector-emitter saturation voltage ²⁾ $I_C = 20 \text{mA}, I_B = 1 \text{mA}$	V_{CEsat}	-	-	0.3	V
Input off voltage $I_C = 100 \mu\text{A}, V_{CE} = 5 \text{V}$	$V_{i(off)}$	0.8	-	1.5	
Input on voltage $I_C = 2 \text{mA}, V_{CE} = 0.3 \text{V}$	$V_{i(on)}$	0.8	-	2.5	
Input resistor	R_1	1.5	2.2	2.9	k Ω
Resistor ratio	R_1/R_2	0.9	1	1.1	-

AC Characteristics

Transition frequency $I_C = 10 \text{mA}, V_{CE} = 5 \text{V}, f = 1 \text{MHz}$	f_T	-	140	-	MHz
Collector-base capacitance $V_{CB} = 10 \text{V}, f = 1 \text{MHz}$	C_{cb}	-	3	-	pF

¹⁾For calculation of R_{thJA} please refer to Application Note Thermal Resistance

²⁾Pulse test: $t < 300 \mu\text{s}$; $D < 2\%$

DC current gain $h_{FE} = f(I_C)$

$V_{CE} = 5V$ (common emitter configuration)

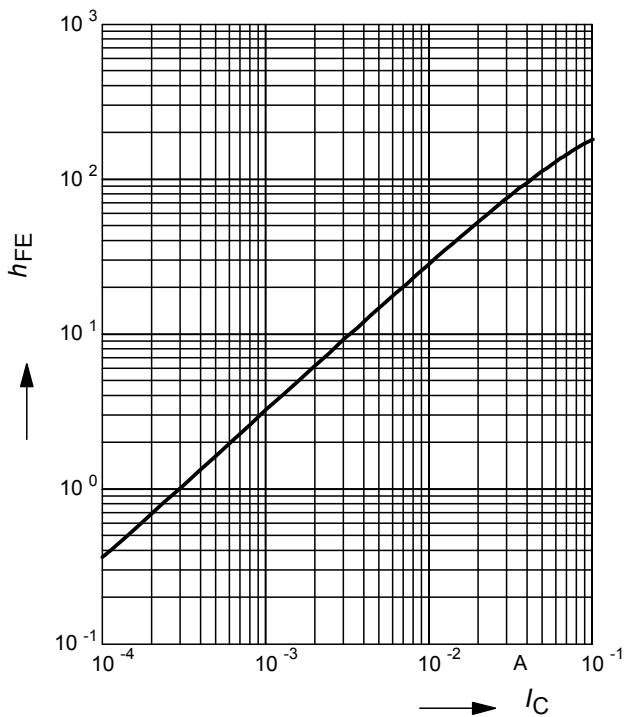

Collector-emitter saturation voltage

$V_{CEsat} = f(I_C), h_{FE} = 20$

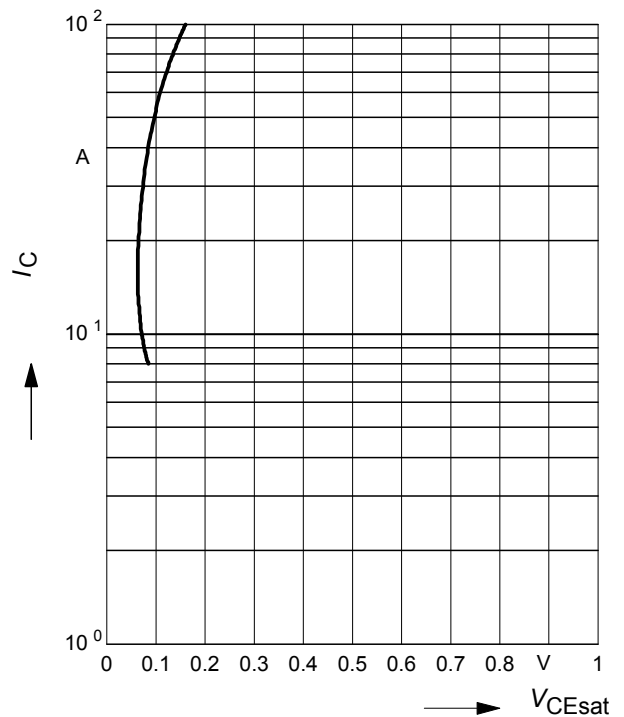

Input on Voltage $V_{i(on)} = f(I_C)$

$V_{CE} = 0.3V$ (common emitter configuration)

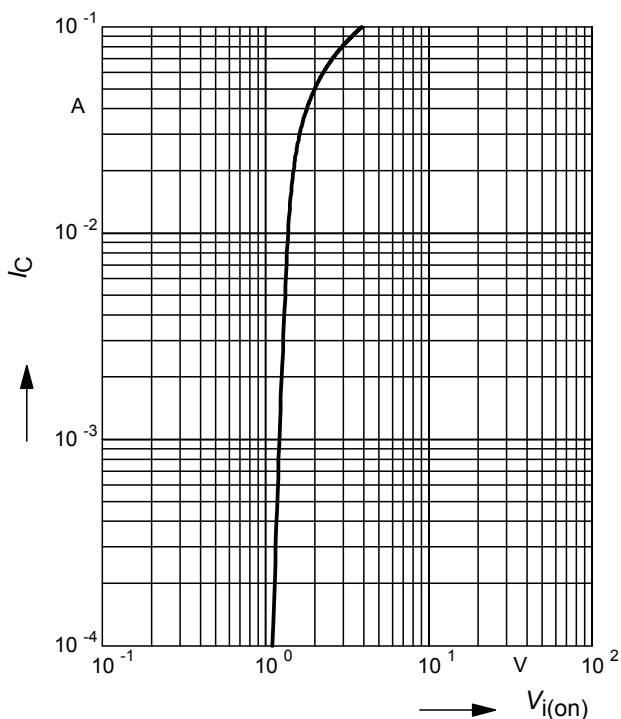

Input off voltage $V_{i(off)} = f(I_C)$

$V_{CE} = 5V$ (common emitter configuration)

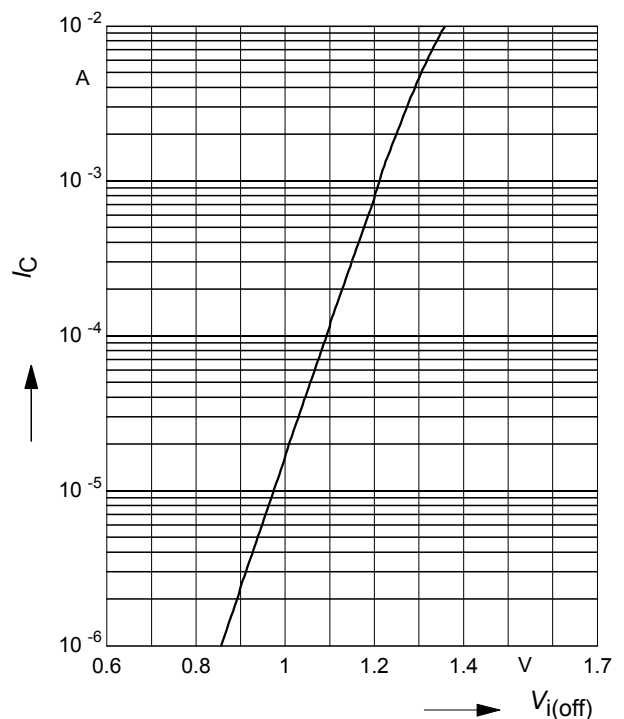

Total power dissipation $P_{tot} = f(T_S)$

BCR103F

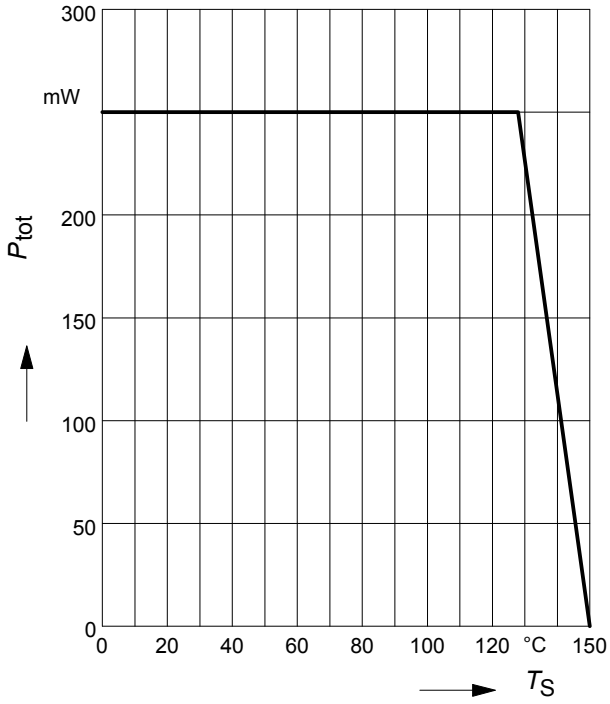

Total power dissipation $P_{tot} = f(T_S)$

BCR103L3

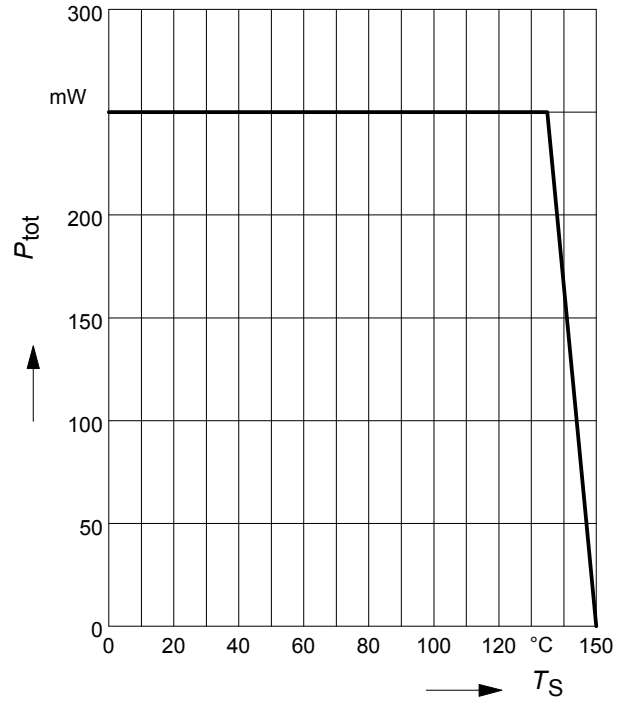

Total power dissipation $P_{tot} = f(T_S)$

BCR103T

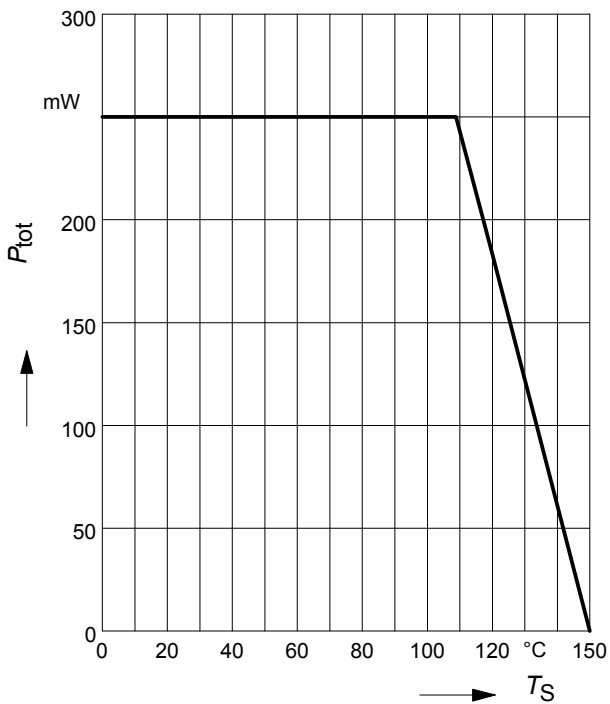

Permissible Puls Load $R_{thJS} = f(t_p)$

BCR103F

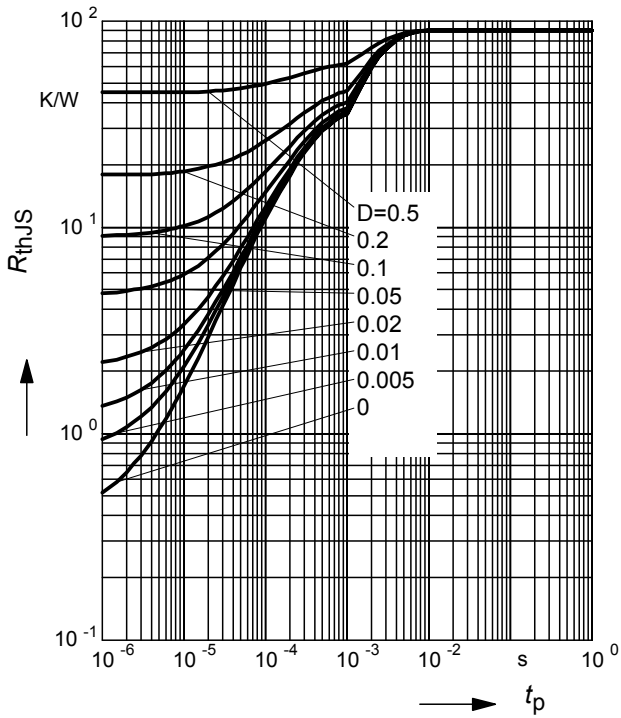

Permissible Pulse Load

$P_{totmax}/P_{totDC} = f(t_p)$

BCR103F

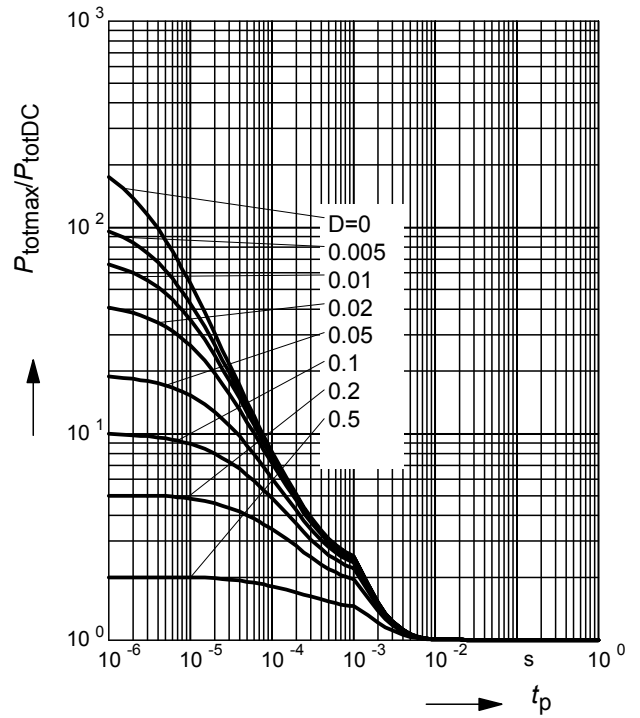

Permissible Puls Load $R_{thJS} = f(t_p)$

BCR103L3

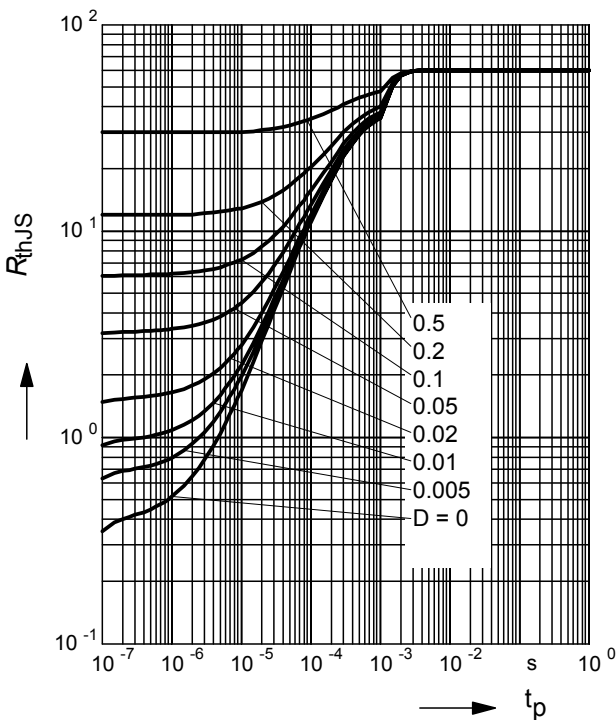

Permissible Pulse Load

$P_{totmax}/P_{totDC} = f(t_p)$

BCR103L3

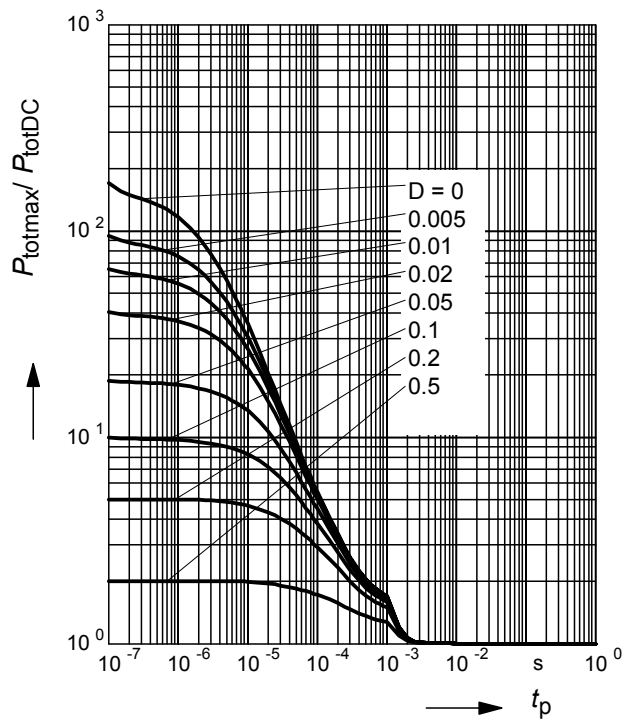

Permissible Puls Load $R_{thJS} = f(t_p)$

BCR103T

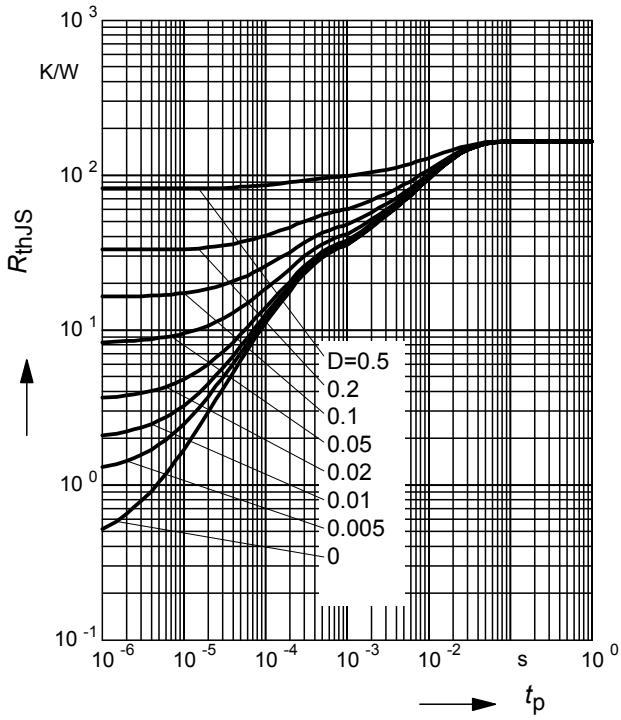

Permissible Pulse Load

$P_{totmax}/P_{totDC} = f(t_p)$

BCR103T

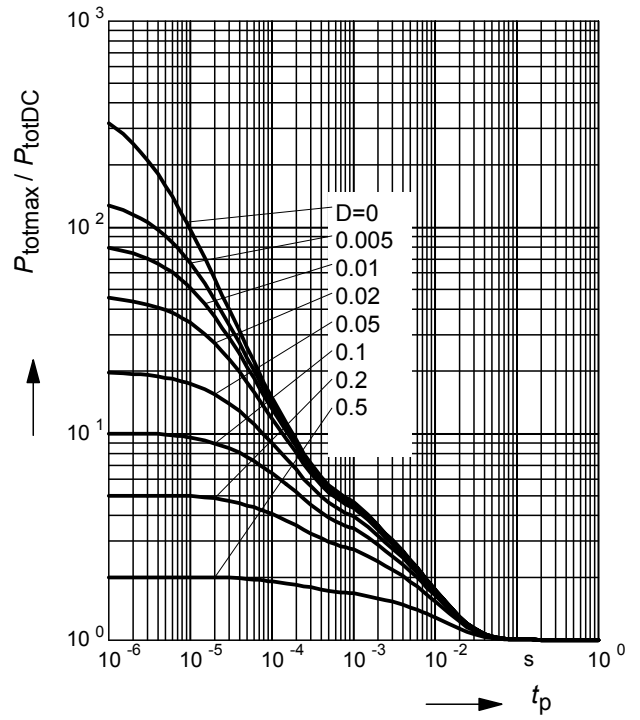

Package Outline

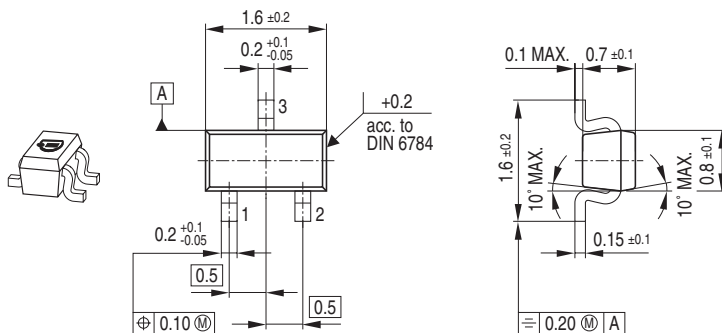

Foot Print

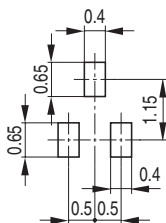

Marking Layout

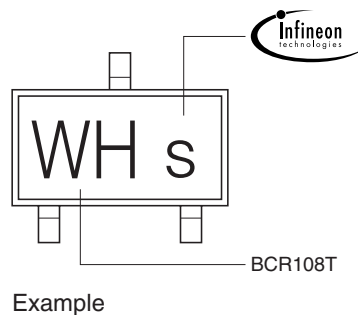
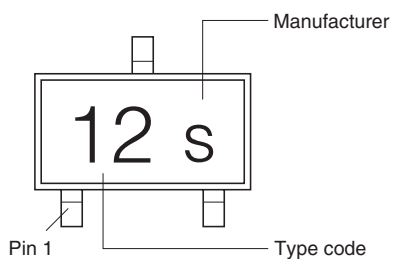

Packing

Code E6327: Reel $\varnothing 180 \text{ mm} = 3.000 \text{ Pieces/Reel}$
 Code E6433: Reel $\varnothing 330 \text{ mm} = 10.000 \text{ Pieces/Reel}$

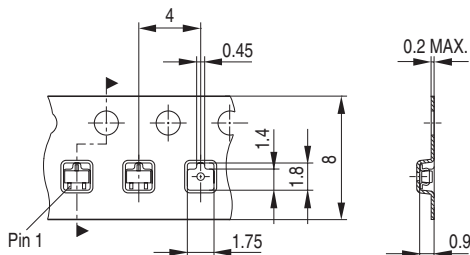

Package Outline

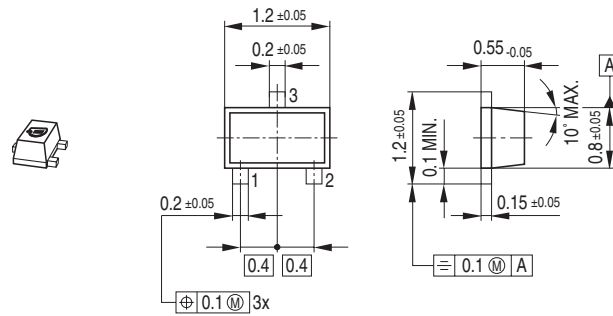

Foot Print

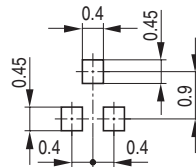

Marking Layout

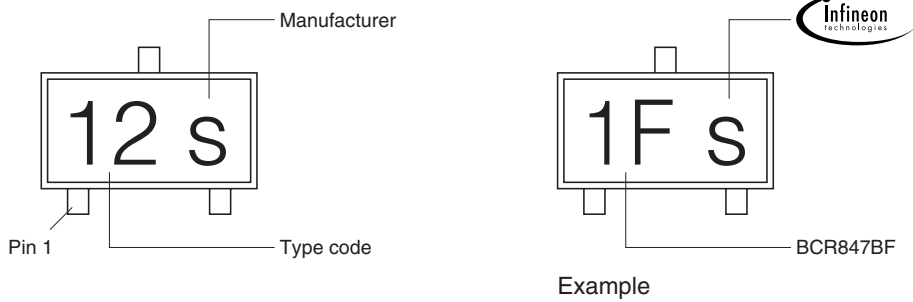

Packing

Code E6327: Reel $\varnothing 180 \text{ mm} = 3.000 \text{ Pieces/Reel}$
 Code E6433: Reel $\varnothing 330 \text{ mm} = 10.000 \text{ Pieces/Reel}$

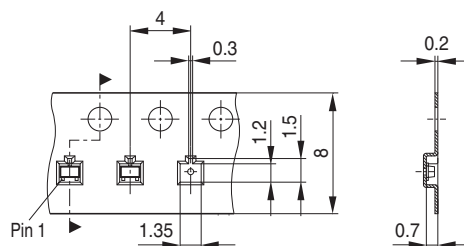

Package Outline

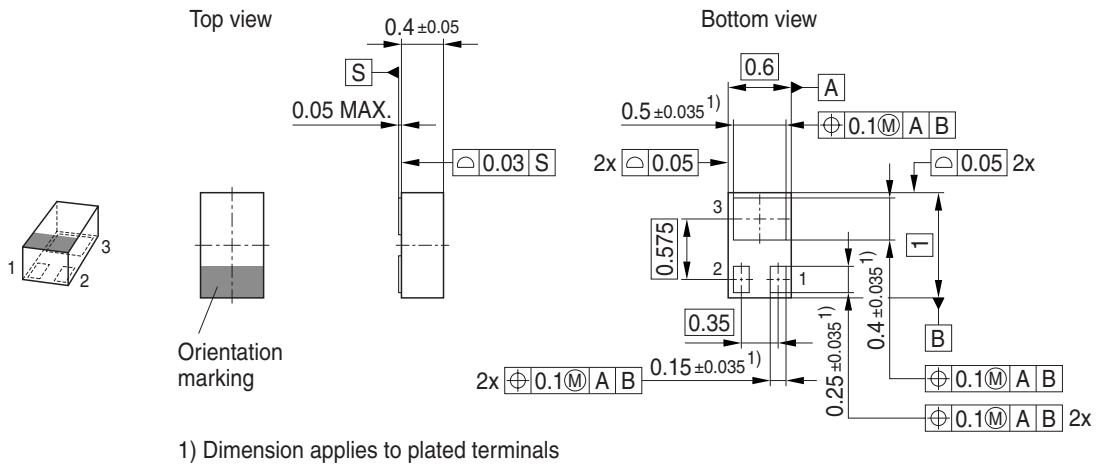

Foot Print

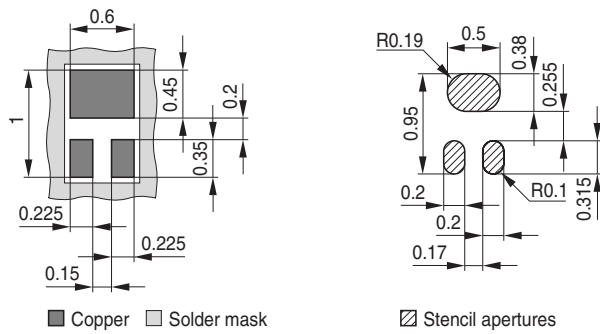

Marking Layout

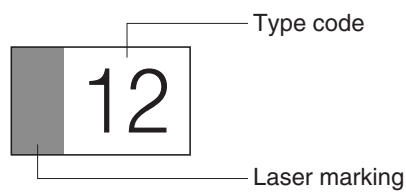

Packing

Code E6327: Reel $\varnothing 180 \text{ mm} = 15.000 \text{ Pieces/Reel}$

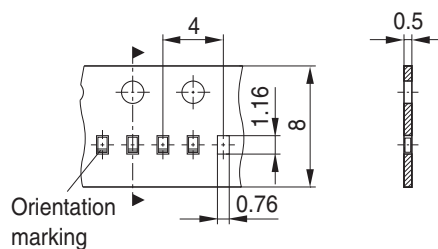

Published by Infineon Technologies AG,
St.-Martin-Strasse 53,
81669 München
© Infineon Technologies AG 2005.
All Rights Reserved.

Attention please!

The information herein is given to describe certain components and shall not be considered as a guarantee of characteristics.

Terms of delivery and rights to technical change reserved.

We hereby disclaim any and all warranties, including but not limited to warranties of non-infringement, regarding circuits, descriptions and charts stated herein.

Information

For further information on technology, delivery terms and conditions and prices please contact your nearest Infineon Technologies Office (www.infineon.com).

Warnings

Due to technical requirements components may contain dangerous substances. For information on the types in question please contact your nearest Infineon Technologies Office.

Infineon Technologies Components may only be used in life-support devices or systems with the express written approval of Infineon Technologies, if a failure of such components can reasonably be expected to cause the failure of that life-support device or system, or to affect the safety or effectiveness of that device or system. Life support devices or systems are intended to be implanted in the human body, or to support and/or maintain and sustain and/or protect human life. If they fail, it is reasonable to assume that the health of the user or other persons may be endangered.